

The World Leader in Pinch and Check Valve Technology™

Continuing a Legacy of Leadership, Innovation and Customer Service

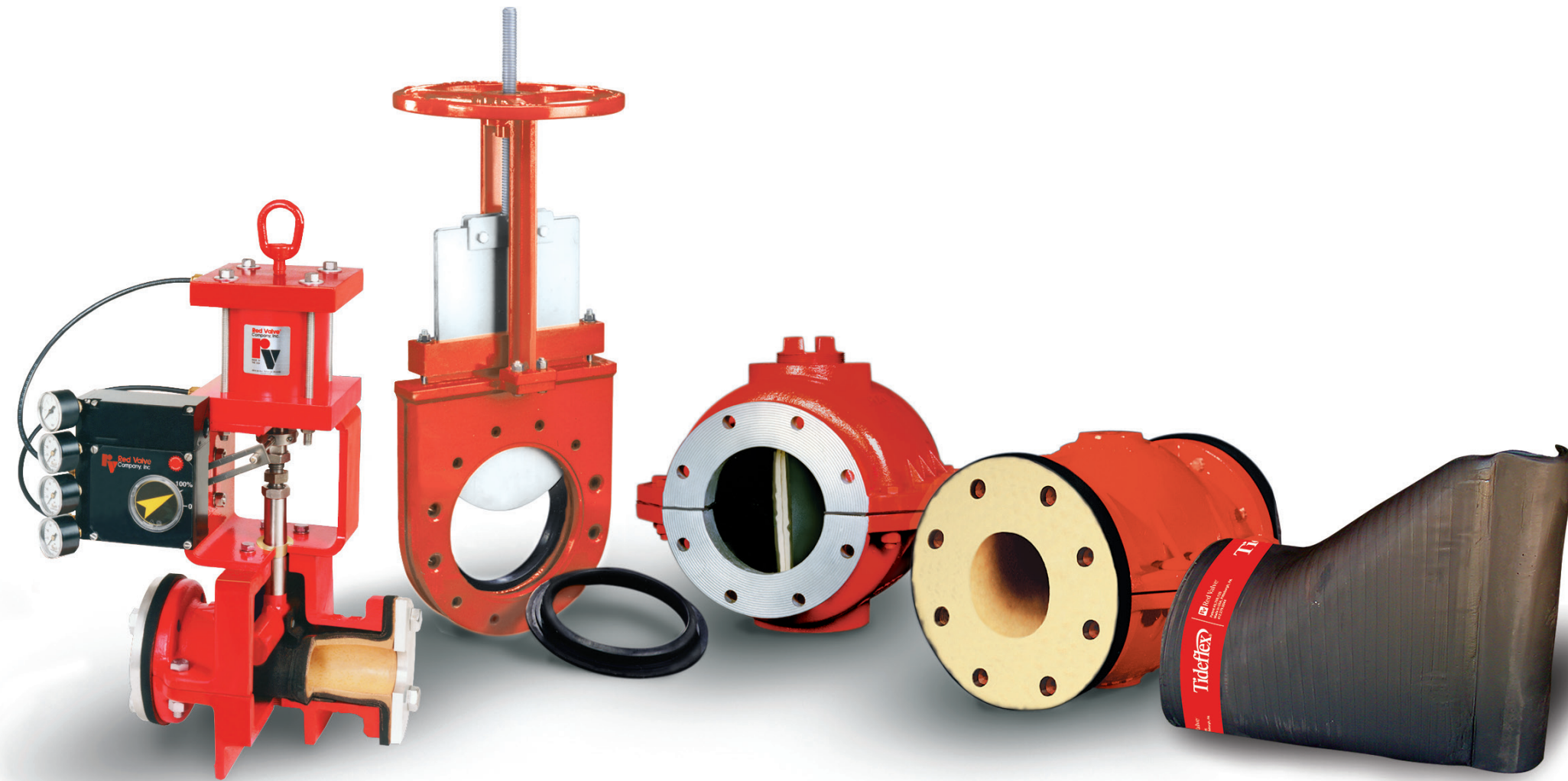

More than 65 years ago, Red Valve Company was founded on a simple promise: manufacture the world's highest quality engineered pinch and check valves, with an unsurpassed level of technical innovation. This promise began a Legacy of Leadership—a never-ending quest to solve customers' toughest challenges and exceed their expectations that continues today.

Being The World Leader in Pinch and Check Valve Technology™ is more than a slogan—it's a promise. This promise lives on every day with every Pinch Valve, Control Valve, Pressure Sensor, Expansion Joint, Tideflex® and CheckMate® In-Line Check Valve we ship to customers all over the world. It's a promise kept every day by hundreds of dedicated global Red Valve employees and independent sales representatives.



Measurit.com



Wastewater Treatment



Mining



Chemical

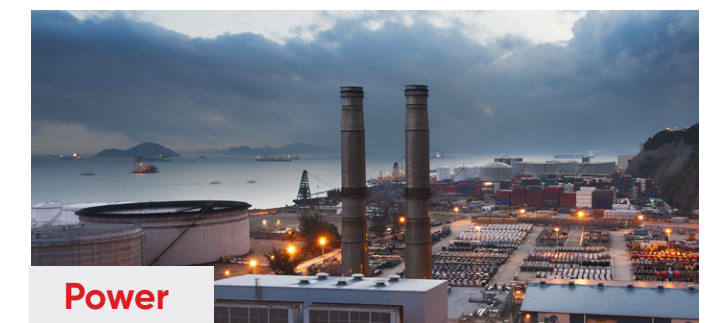

Power



Pulp and Paper

The World Leader in Elastomer Sleeve Technology

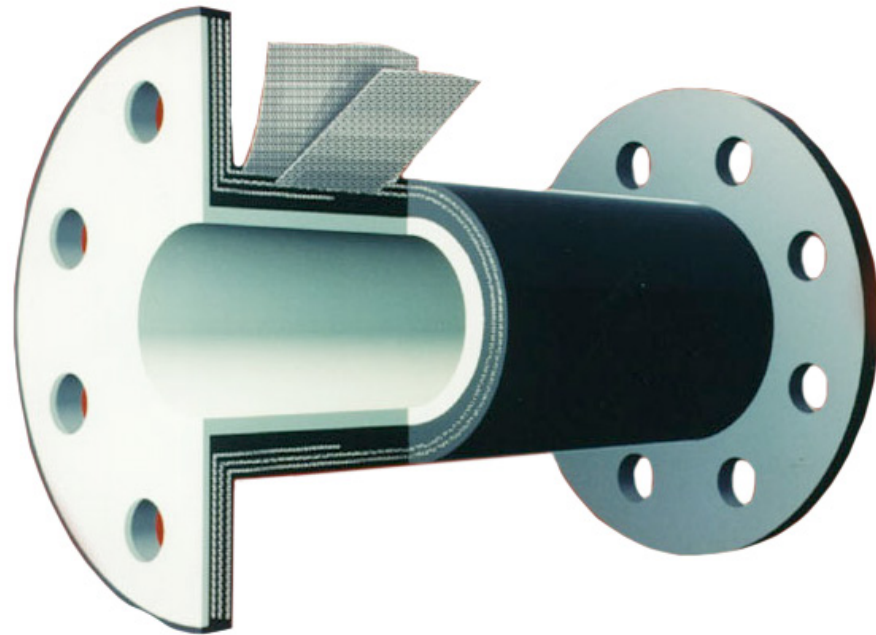

- Full face-to-face integral elastomer molded flange
- Manufactured to the highest standards
- Superior service life
- Standard, cone, double wall or high-pressure trim
- Sleeves available in a wide variety of elastomers
- Custom sizes available
- Available with smart sleeve technology to electronically sense

The quality of any pinch valve rests in the quality of its sleeve. The pinch sleeve is truly the “heart” of the pinch valve, providing corrosion resistance, abrasion resistance and pressure containment.

Red Valve has manufactured the industry’s finest sleeves continuously since 1953. Red Valve incorporates industry-leading proprietary technology in elastomer compounding and synthetic materials, which results in the world’s most trouble-free, highly wear-resistant pinch valve sleeves that outperform and outlast all other designs.

The sleeve is the only replacement part required. There are no seats, packing, seals or bellows to routinely replace. Once a sleeve is replaced, the valve is like new again. There is little need to inventory other valve parts.

Elastomer Selections:

- Pure Gum Rubber
- Fluoroelastomer
- Neoprene
- Hypalon
- EPDM
- Chlorobutyl
- Buna-N
- Food Grade Materials

Sleeve Trim Selection

Standard Sleeves are highly specialized components. Great care is taken to match the specific elastomer, pressure rating and temperature limits for each application, ensuring longest possible maintenance-free service life. The Standard Sleeve’s Full Port provides uninterrupted flow like another piece of pipe, and flow remains streamlined when throttled.



Standard Sleeve

Cone Sleeves, patented by Red Valve, are designed for control applications. Cone Sleeves provide tighter control with a 20:1 turndown ratio and 0.89 pressure recovery factor. Extra elastomer thickness on the downstream side of the cone increases service life.



Patented Cone Sleeve

Double Wall Sleeves are designed for extremely abrasive slurries. The Double Wall Sleeve has triple the thickness of elastomer than Standard Sleeves. The next larger valve size is specified with Double Wall Sleeves to maintain full port due to additional sleeve thickness.

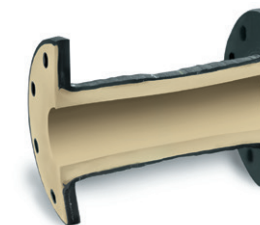

Double Wall Sleeve

High-Pressure Sleeves are designed for high-pressure ANSI 300 applications up to 720 psi. The High-Pressure Sleeve features stronger fabric reinforcement and thicker construction than Standard Sleeves. Face flanges are equipped with integrated o-ring seals to ensure a tight seal under high-pressure applications.



High-Pressure Sleeve

Pinch Valves Outlast Traditional Alloy Valves

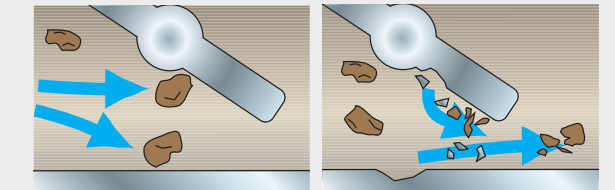

When abrasive particles strike the hard surface of traditional metal valves, the energy of the impact is completely absorbed by the metal surface, prematurely wearing seats, weirs, rotating discs, plugs and balls. Additionally, these abrasive particles pack behind the ball and plug, scoring the sealing surface and creating leaks.

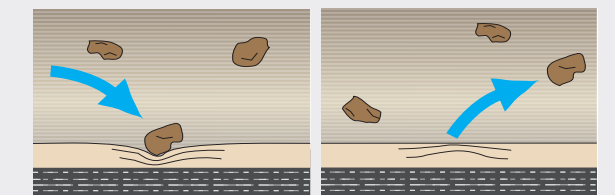

When abrasive particles strike elastomer surfaces, the impact is absorbed, then deflected back into the particle. Extremely resilient elastomers wear at a far slower rate than ceramics or metal alloy valve trims. Pinch valves are full-ported with no crevices, packing glands or seats to foul valve operation.

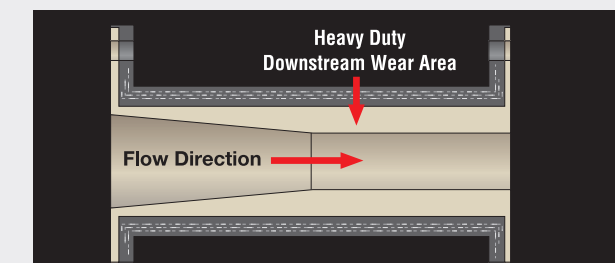

Cone Sleeve Advantage

Cone sleeve trim provides tighter control with a 20:1 turndown ratio and 0.89 recovery factor. Pressure recovery occurs downstream of the sleeve, so cone sleeves can handle a higher pressure drop than other sleeve designs.

Series 70 and 75 Manual Pinch Valves

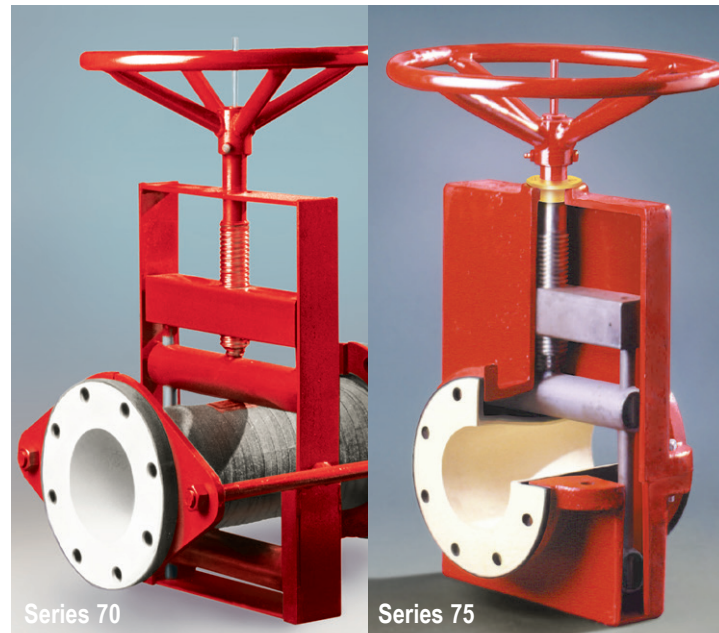

Materials of Construction

- Series 70** Available in sizes 1" - 48"
Series 75 Available in sizes 1" - 12"
Series 70 Body: Carbon steel fabricated
Series 75 Body: Cast iron or aluminum body
Sleeves: Pure gum rubber, EPDM, Buna-N, Fluoroelastomer, Neoprene, Hypalon, Chlorobutyl
Drilled and tapped flanges:
- ANSI 150#
 - ANSI 300#
 - ANSI B16.1 125# cast flanges
 - AWWA C110 125# flanges
 - EN1092 PN 6, 10 & 16
 - JIS 5K, 10K
 - Other drill patterns available upon request
- Optional:** Extended stems and torque tubes, floorstands, chainwheels, limit switches

Series 70 and 75 Manually Operated Pinch Valves are reliable, maintenance-free, cost-effective valves designed for slurry, abrasive and corrosive-chemical applications. There are no seats to grind, no stuffing boxes to repack and no packing glands to adjust, ever. The pinching action is on centerline, so the valve closes on a smooth venturi and is self-cleaning.

- The durable, flexible rubber sleeve is reinforced with high-strength fabric and the only part exposed to the line process, eliminating maintenance and the need for expensive materials.
- Valve operation will not freeze and operating torques remain constant. Design principle is simple – two mechanical pinch bars open and close the elastomer sleeve.
- Excellent control characteristics allow this valve to be used as a variable orifice. Few manual valves have this throttling advantage. Zero leakage is maintained bi-directionally.
- Multiple options are available, such as the Series 75B design for buried service conditions. AWWA nuts, chainwheels, stem extensions and bevel gear actuators are also available.

Type A Air-Operated Pinch Valve

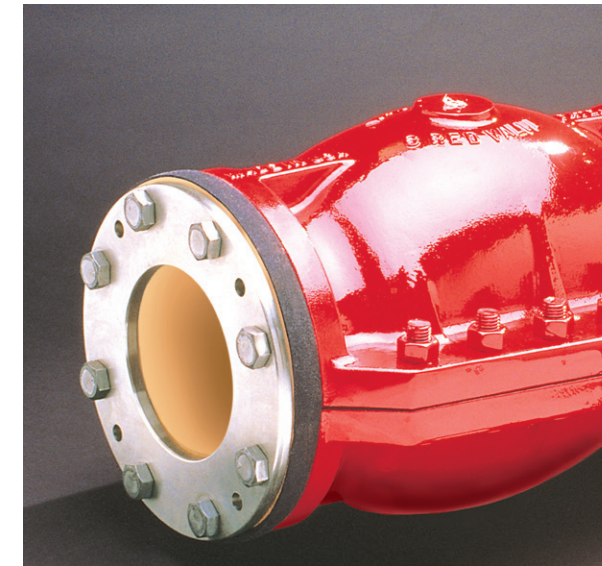

Materials of Construction

- Available in sizes 1" - 28"
Body: Cast iron or aluminum
Sleeves: Pure gum rubber, EPDM, Buna-N, Fluoroelastomer, Neoprene, Hypalon, Chlorobutyl
Drilled and tapped flanges:
- ANSI 150#
 - ANSI B16.1 125# cast flanges
 - AWWA C110 125# flanges
 - EN1092 PN 6, 10 & 16
 - JIS 5K, 10K
 - Other drill patterns available upon request
- Accessories:** Controls and control systems

Introduced and patented by Red Valve, the air-actuated Type A Pinch Valve offers a unique, cost-effective solution to flow control problems. Actuation of the valve is accomplished by air or hydraulic pressure placed on the sleeve. The valve body acts as a built-in actuator, eliminating costly pneumatic, hydraulic or electric actuators. Modulating the air pressure within the annular space between the body and the sleeve can open, throttle or close the valve.

- Approximately 35 psi over line pressure is required for closure.
- Flexible sleeve closes drop-tight around entrapped solids, eliminating hang-ups that could damage the valve.
- Sealing area equal to 95% of the valve's length.
- No seats or packing to replace, no cavities or dead spots to collect debris.
- Ideal for remote locations or harsh environments; no external links, levers, pistons or rotating parts to cause downtime.

Type A Megaflex Air-Operated Pinch Valve

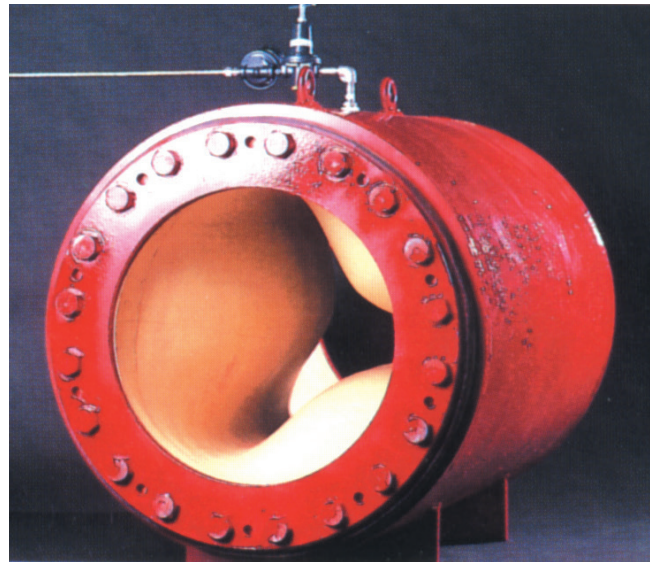

Materials of Construction

Available in sizes 30" - 84"

Body: Carbon steel

Sleeves: Pure gum rubber, EPDM, Buna-N, Fluoroelastomer, Neoprene, Hypalon, Chlorobutyl

Drilled and tapped flanges:

- ANSI 150#
- ANSI B16.1 125# cast flanges
- AWWA C110 125# flanges
- EN1092 PN 6, 10 & 16
- JIS 5K, 10K
- Other drill patterns available upon request

Accessories: Controls and control systems

First introduced by Red Valve, the Type A Megaflex Valve is extremely simple in design and principle. The Megaflex Valve's full-ported actuation is accomplished by air or hydraulic pressure. The steel body acts as a built-in actuator, eliminating costly pneumatic, electric or hydraulic components. Pressure within the space between the body and the sleeve opens, throttles or closes the valve. Unlike traditional gate and butterfly valve designs, there are no discs or gates to obstruct flow or create turbulence.

- The most economical large-diameter automatic valve available. No need for costly actuators.
- Substantial savings are realized due to minimal headloss, substantially reducing pumping costs.
- Ideal as effluent discharge valves controlling raw sewage, storm overflow, flow equalization, tailings in mining operations and bulk material handling.

Series 2600 Miniflex Air-Operated Pinch Valve



Materials of Construction

Available in sizes 1/8" - 3"

Body: Steel or stainless steel

Sleeves: Pure gum rubber, EPDM, Buna-N, Fluoroelastomer, Neoprene, Hypalon, Chlorobutyl

Drilled and tapped flange ends:

- ANSI NPT threaded ends
- Metric threaded ends
- Food grade sanitary ends
- Other drill patterns available upon request

Accessories: Controls and control systems

Manufactured on the same design principles as Red Valve's Type A Valve, Series 2600 Miniflex Valves are the simplest and least expensive actuated pinch valves available today. The Series 2600 is designed with threaded-end connections, enabling use on small lines (1/8" - 3").

- Pneumatically actuated, valve body is a built-in actuator.
- Air pressure opens and closes the rubber sleeve, eliminating costly actuators or electric motors and maintenance costs.
- Only 25 psi over line pressure required for closure. Threaded-end connections enable easy installation and removal.
- Cycles rapidly, ideal for sampling, filling and controlling.
- Excellent choice for chemical feed, dry powder, bagging and plastic molding applications.

Series 5200 Control Pinch Valve

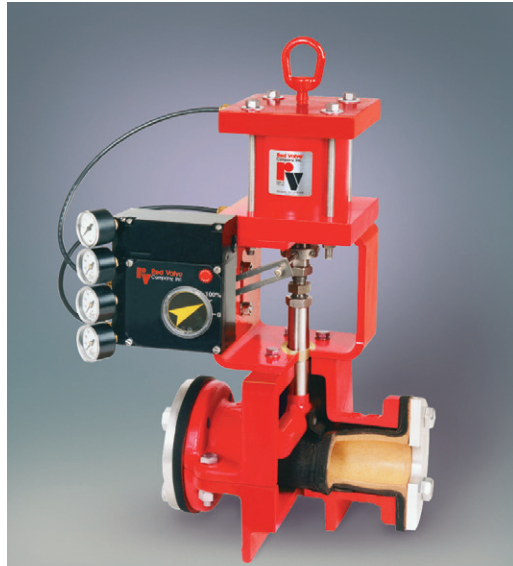

Materials of Construction

Available in sizes 1" - 48"

Body: Ductile cast iron

Sleeves: Pure gum rubber, EPDM, Buna-N, Fluoroelastomer, Neoprene, Hypalon, Chlorobutyl

Drilled and tapped flanges:

- ANSI 150#
- ANSI B16.1 125# cast flanges
- AWWA C110 125# flanges
- EN1092 PN 6, 10 & 16
- JIS 5K, 10K
- Other drill patterns available upon request

Optional: Extended stems and torque tubes, floorstands, control components

The Red Valve Series 5200 Control Pinch Valve offers maximum durability with precise control with virtually zero maintenance. The heavy-duty pinch mechanism positions the sleeve for accurate control over a wide flow range. The valve has no packing to maintain or seats to wear, and the elastomer sleeve eliminates the need for expensive alloy bodies.

In sizes over 4", a bottom pinch bar is used to reduce the stroke length of the valve by pre-pinching the sleeve into a D-shaped port, providing more immediate response to control signal with no loss of flow capacity.

- Cone Sleeves can be specified to further enhance control performance and match the exact Cv level desired.
- True feedback positioning is accomplished through the direct linkage of the pneumatic positioner to the valve stem shaft.
- No splitting of the positioner output.
- True-feedback positioning greatly enhances control accuracy.

Series 5200E Control Pinch Valve



Materials of Construction

Available in sizes 1" - 48"

Body: Ductile cast iron

Sleeves: Pure gum rubber, EPDM, Buna-N, Fluoroelastomer, Neoprene, Hypalon, Chlorobutyl

Drilled and tapped flanges:

- ANSI 150#
- ANSI B16.1 125# cast flanges
- AWWA C110 125# flanges
- EN1092 PN 6, 10 & 16
- JIS 5K, 10K
- Other drill patterns available upon request

Optional: Extended stems and torque tubes, floorstands, control components

The Series 5200E Electrically Actuated Control Pinch Valve is a highly reliable, maintenance-free valve designed for tough slurry and abrasive applications. There are no seats to grind, no stuffing boxes to repack and no packing glands to adjust, ever. The rugged, self-cleaning elastomer sleeve isolates all mechanical parts of the valve, so the breakaway torque remains constant.

- Valves are actuated by AUMA®, Limitorque® or Rotork® electric operators as a standard and include heaters, thermostats, position indicators and indication lights.
- Other electric motor operators are available as a separate unit for a remote station.
- Optional features include NEMA 7 explosion-proof construction, proportioning control from a 4-20 mA instrument signal and 4-20 mA output transmitter.

Series 5300 Control Pinch Valve



Materials of Construction

Available in sizes 2" - 48"

Body: Carbon steel or stainless steel frame

Sleeves: Pure gum rubber, EPDM, Buna-N, Fluoroelastomer, Neoprene, Hypalon, Chlorobutyl

Drilled and tapped flanges:

- ANSI 150#
- ANSI 300#
- ANSI B16.1 125# cast flanges
- AWWA C110 125# flanges
- EN1092 PN 6, 10 & 16
- JIS 5K, 10K
- Other drill patterns available upon request

The Series 5300 Control Pinch Valve features many of the same advantages of the Series 5200 in a lightweight, low-cost, open-frame design. The open-frame design is possible because the sleeve is the only wetted part of the pinch valve, protecting the operating mechanism and frame from corrosive or abrasive attack from the line process.

- Heavy-duty, rugged pinch mechanism pinches the sleeve, resulting in accurate flow control.
- No packing to maintain or seats to wear.
- Ideal for handling corrosives, powders and slurry materials.
- Pneumatic, electric or hydraulic actuators available, complete with pneumatic or electro-pneumatic positioners.
- Valve sizes up to 6" are designed with a stroke adjustment located inside valve yoke enabling small control changes in the field and simplifying actuator maintenance by creating removal point in the valve stem.

Series 5400 Control Pinch Valve



Materials of Construction

Available in sizes 4" - 36"

Body: Ductile cast iron

Sleeves: Pure gum rubber, EPDM, Buna-N, Fluoroelastomer, Neoprene, Hypalon, Chlorobutyl

Drilled and tapped flanges:

- ANSI 150#
- ANSI B16.1 125# cast flanges
- AWWA C110 125# flanges
- EN1092 PN 6, 10 & 16
- JIS 5K, 10K
- Other drill patterns available upon request

Red Valve's Series 5400 Control Pinch Valve features centerline closure, true feedback positioning, a compact size and accurate, repeatable variable venturi flow control. Centerline closure is extremely important for larger size pinch sleeves on abrasive and high-velocity applications. It outlasts all other types of gate, plug or ball valves on control of abrasive and corrosive slurries. The resilient elastomer sleeve outlasts even stellite-coated control valves.

- Cone Sleeves can be specified to further enhance control performance and match the exact Cv level desired.
- True feedback positioning is accomplished through the direct linkage of the pneumatic positioner to the valve stem shaft.
- True feedback positioning enables accurate, small responsive signal changes to the positioner, achieving similar changes in true valve position, greatly enhancing control accuracy and repeatability.

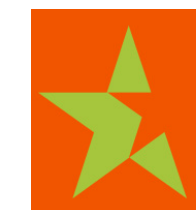

Measurit.com

Series 5700 Control Pinch Valve



Materials of Construction

Available in sizes 4" - 48"

Body: Ductile cast iron

Sleeves: Pure gum rubber, EPDM, Buna-N, Fluoroelastomer, Neoprene, Hypalon, Chlorobutyl

Drilled and tapped flanges:

- ANSI 150#
- ANSI B16.1 125# cast flanges
- AWWA C110 125# flanges
- EN1092 PN 6, 10 & 16
- JIS 5K, 10K
- Other drill patterns available upon request

Optional: Extended stems and torque tubes, floorstands, control components

Full-port opening and centerline closure is extremely important for larger size pinch valves in abrasive and high-velocity applications. Patented by Red Valve Company in 1983, the cost-effective Series 5700 Control Pinch Valve with centerline closure outlasts all other types of gate, plug or ball valves on control of abrasive and corrosive slurries.

- The valve offers a 100% full round port opening and Class V shut-off. In throttling service, the Series 5700 provides true feedback positioning, and accurate, repeatable variable venturi flow control.
- No seats to grind, no stuffing box to repack and no packing gland to adjust, ever.
- The rugged, self-cleaning elastomer sleeve isolates all mechanical parts of the mechanism, so the operating torque remains constant.
- Cone Sleeves can be specified to further enhance control performance and match the exact Cv level desired.
- True feedback positioning is accomplished through the direct linkage of the pneumatic positioner to the valve stem shaft.

Series RSR Pressure Relief Valve



Materials of Construction

Available in sizes 1" - 12"

Body: Ductile iron

Sleeves: Pure Gum Rubber, Neoprene, Hypalon, Chlorobutyl, Polyurethane, Buna-N, Viton, and EPDM

Actuator: Red Valve Fail Close

Drilled and tapped flanges:

- Ansi Class 125#
- Ansi Class 150#
- Other drill patterns available upon request

Optional: Accessory system for handling sustained surges

The Red Valve Series RSR Pressure Relief Valve is specifically designed for slurry applications and is reliable to vent surge pressures in the system and maintain system pressure.

- Uses a spring loaded cylinder to hold the rubber pinch valve closed, only opening when the process pressure builds up and exceeds tension. The higher the pressure the more the valve opens
- The sleeve isolates the pinch mechanism, which eliminates corrosion, bridging, plugging, and freezing
- The accessible adjustment nut allows for easy external recalibration, correction and fine-tuning of the system



Measurit.com

Series 9000 High-Pressure Control Pinch Valve



Materials of Construction

Available in sizes 1" - 12"

Body: Ductile cast iron

Sleeves: Pure gum rubber, EPDM, Buna-N, Fluoroelastomer, Neoprene, Hypalon, Chlorobutyl

Drilled and tapped flanges:

- ANSI 150#
- ANSI 300#
- ANSI B16.1 125# cast flanges
- AWWA C110 125# flanges
- EN1092 PN 6, 10 & 16
- JIS 5K, 10K
- Other drill patterns available upon request

Optional: Extended stems and torque tubes, floorstands, control components

The Series 9000 High-pressure Pinch Control Valve is Red Valve's ANSI Class 300 valve product. With Red Valve's Double Wall Sleeve, the valve features increased abrasion resistance and can accommodate pressures up to 720 psi.

- Available with Red Valve's patented Cone Sleeve for control applications and Standard Sleeve for lower pressure requirements.
- Heavy-duty solid stroke adjustment unit located on valve base enables fine-tuned control and stroke adjustment for reduced sleeve wear due to abrasion.
- Available with bevel gear actuators for manual operation, hydraulic or electric actuators for automatic operation and pneumatic actuators for small sizes or low-pressure applications.
- For applications with low-pressure requirements, the Series 9000 is also available in ANSI Class 150 drilling configurations.

Series DX Knife Gate Valve



Materials of Construction

Available in sizes 3" - 30"

Body: Ductile cast iron 3" - 24", fabricated carbon steel 3" and larger

Gate: 316L stainless steel, 17-4 PH, Duplex, C-276

Seats: Natural rubber, EPDM, Buna-N, Neoprene

Gate coating: Fluoroelastomer polymers

Drilled and tapped flanges:

- ANSI 150#
- ANSI 300#
- ANSI B16.1 125# cast flanges
- AWWA C110 125# cast flanges
- EN1092 PN 6, 10 & 16
- JIS 5K, 10K
- Other drill patterns available upon request

Optional: Splash guard and pipe away containment

Red Valve's Series DX Slurry Knife Gate Valves are the most durable and user-friendly valves available for difficult slurry applications. The fully elastomer-lined DX Valve prevents slurry build-up or dewatering by eliminating the seat cavity. Bodies made from ductile iron provide a ruggedness that can only be provided by castings having significant elongation.

- Reinforced elastomer sleeves seal against each other, providing a 100% full-port opening, minimizing turbulence and wear when valve is open. Seats isolate and protect all metal parts from coming in contact with process.
- When closed, sleeve provides drop-tight seal in both directions.
- Each time the DX Valve strokes, it discharges a small amount of slurry, keeping gate path clear and preventing slurry build-up which might otherwise prohibit the valve's ability to close.
- Both sleeves and gates are field-replaceable. A wiper blade mounted on top of the valve prevents the gate lubricant and process from leaking through the top and external grit from entering the valve body.
- DX Valve's plate-style splash guard controls slurry discharging from the slot in the valve.

Series D Flexgate Manual Knife Gate Valve



Materials of Construction

Available in sizes 3" - 42"

Body: Ductile cast iron 3" - 12", cast iron 14" - 36"

Gate: 316L stainless steel, 17-4 PH, Duplex, C-276

Seats: Natural rubber, EPDM, Buna-N, SBR, Fluoroelastomer, Neoprene

Gate coating: Fluoroelastomer polymers

Drilled and tapped flanges:

- ANSI 150#
- ANSI 300#
- ANSI B16.1 125# cast flanges
- AWWA C110 125# cast flanges
- EN1092 PN 6, 10 & 16
- JIS 5K, 10K
- Other drill patterns available upon request

Optional: Extended stems and torque tubes, floorstands

Red Valve's Series D Flexgate Manual Valves are built with a cast or fabricated body and feature heavy-duty stainless steel gates. Ductile cast iron bodies provide enhanced performance where external and internal factors demand materials providing significant elongation.

- Removable rubber cartridge seats on either side of the gate provide a bi-directional seal and excellent wear resistance. Seats are metal-reinforced and available in a wide variety of elastomers for abrasion resistance and chemical compatibility.
- Port at valve base allows for easy flushing.
- The Flexgate Valve provides a bi-directional shutoff.
- Heavy-duty top works come standard; the valve's simple design eliminates expensive overhauls, unscheduled shutdowns and costly replacement parts – the only replacement parts are the slurry seats and packing.
- Red Valve Flexgate Valves of 3" - 12" are provided with standard handwheel mechanisms featuring cast iron handwheels, machined 303 stainless steel stems with yoke sleeves and thrust washers designed to reduce operating torque.
- Flexgate Valves 14" and larger feature fabricated (tubular) handwheels. It is recommended that manual Flexgate Valves 12" and larger be specified with a 4:1 bevel gear actuator to reduce rim pull.

Series D Flexgate Actuated Knife Gate Valve



Materials of Construction

Available in sizes 3" - 42"

Body: Ductile cast iron 3" - 12", cast iron 14" - 36"

Gate: 316L stainless steel, 17-4 PH, Duplex, C-276

Seats: Natural rubber, EPDM, Buna-N, SBR, Fluoroelastomer, Neoprene

Gate coating: Fluoroelastomer polymers

Drilled and tapped flanges:

- ANSI 150#
- ANSI 300#
- ANSI B16.1 125# cast flanges
- AWWA C110 125# cast flanges
- EN1092 PN 6, 10 & 16
- JIS 5K, 10K
- Other drill patterns available upon request

Optional: Extended stems and torque tubes, floorstands, control components

Red Valve's Series D Flexgate Actuated Knife Gate Valves are available with pneumatic, electric or hydraulic actuators. The actuated Series D Flexgate Valve provides long-term abrasion resistance under high-cycle conditions. Valve self-cleans each time it is cycled and is ideal for automated operations.

- Pneumatic actuators manufactured using Black Amalgon®, a fiberglass-reinforced epoxy resin, inert to most corrosive chemicals, hydraulic fluids, water and oil. Other options include limit switches, solenoids and air regulators.
- Actuator operating temperature ranges from -90°F to 225°F. Inside actuator walls are polished and impregnated with molydisulfide for reduced friction and wear.
- Valve piston seal is a long-lasting o-ring. The piston rod is sealed with a lip seal, which is protected by a rod wiper ring. The wiper ring prevents dirt from being dragged through the seal.

Pressure Sensors



Materials of Construction

- Series 42** Available in sizes 1/2" - 2"
Series 40 and 48 Available in sizes 2" - 48"
Body: Steel, stainless steel, thermoplastic
Series 42 Sleeves: Pure gum rubber, EPDM, Buna-N, Fluoroelastomer, Neoprene, Hypalon, Chlorobutyl
Series 40 and 48 Sleeves: Pure gum rubber, EPDM, Buna-N, Fluoroelastomer, Neoprene, Hypalon, Chlorobutyl, food grade
Flange Adaptability:
- ANSI 150#
 - ANSI 300#
 - ANSI B16.1 125# cast flanges
 - AWWA C110 125# flanges
 - EN1092 PN 6, 10 & 16
 - JIS 5K, 10K
 - Other drill patterns available upon request
- Accessories:** Digital and analog pressure sensors, transmitters, control systems

Red Valve Pressure Sensors are the industry standard for protecting instrumentation and assuring accurate, dependable pressure measurement of slurry and corrosive fluids. Line pressure is sensed through the 360° flexible rubber sleeve. The captive fluid is displaced through the pressure sensor body to the instrument's Bourdon tube. All instruments are isolated and protected from the process, assuring positive and accurate readings.

The Red Valve standard gauge is bottom mounted with a 2-1/2" diameter steel case; accuracy of this gauge is ±2% of the installed instrument. A gauge having a 0-100 psi range is furnished as standard unless otherwise specified. Gauges covering 0-60 psi and 0-200 psi are optional at no additional cost.

- Full-faced, thru-bolted Series 40 installs directly inline.
- Series 42 is available in sizes 1/2" to 2" for small-diameter, threaded-end pipe.
- Series 48 is wafer-style and available in sizes 10" - 48" for large-diameter pipe.
- Thru-bolted Series 40 can be mounted in any flow direction, submerged in a tank or mounted with a blind flange as a dead end to monitor tank levels.
- Other ranges of pressure gauges, transmitters, transducers, recorders, differential pressure or vacuum switches can be mounted to the Series 40, Series 42 and Series 48.

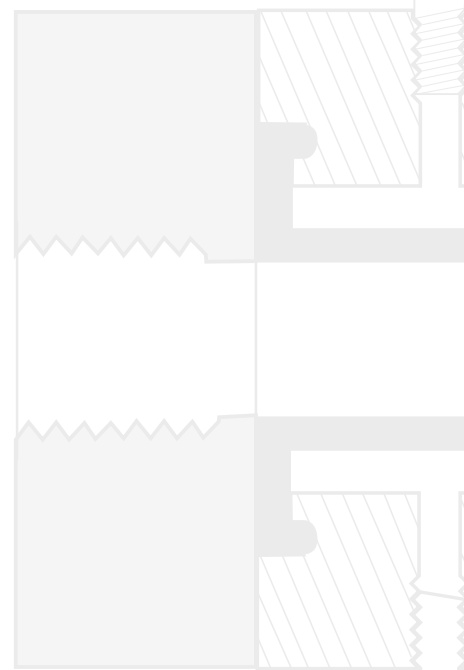

Redflex® Expansion Joints and Rubber Products



Materials of Construction

- Available in sizes 2" - 72"
Body: Pure gum rubber, EPDM, Buna-N, Fluoroelastomer, Neoprene, Hypalon, Chlorobutyl, Fluoroelastomer lined, food grade, NSF-61 certified custom elastomers
Drilled flanges:
- ANSI 150#
 - ANSI 300#
 - ANSI B16.1 125# cast flanges
 - AWWA C110 125# flanges
 - EN1092 PN 6, 10 & 16
 - JIS 5K, 10K
 - Slip-on connections available
 - Other drill patterns available upon request
- Accessories:** Tie rods, gussets, compression sleeves; steel, stainless steel, electrozinc plated, hot dipped galvanized; unfilled and filled arches

Redflex® Expansion Joints and Rubber Products are designed to alleviate piping stress, noise and vibration, permit axial compression and elongation and compensate for lateral and angular movements. Constructed from non-corrosive and abrasion-resistant elastomers, Redflex® Expansion Joints and Rubber Products offer long-term, maintenance-free performance. Joints are available with filled arches or wide, shallow arches for slurry service. Redflex® Expansion Joints and Rubber Products are available with custom offsets, flanges and face-to-face lengths to meet individual design considerations.

- Expansion Joints
- Single or Multiple Arch
- Ducting Joints
- Reducing Joints
- Rubber Reducers
- Rubber Elbows
- Rubber Fittings
- Rubber Pipe
- Vibration Pipe
- Flanged or Slip-On
- Fluoroelastomer Lined
- "Smart" Technology
- Custom-Fabricated
- Sizes 2" to 72"

Types of Movement

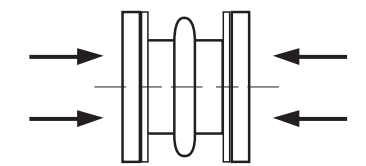

Axial Compression

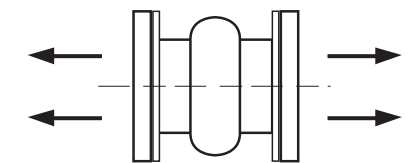

Axial Extension

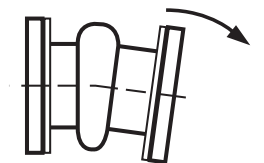

Angular Movement

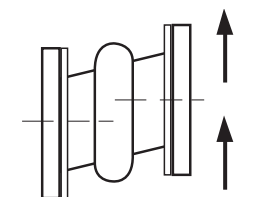

Lateral Deflection

There Is Only One Tideflex® Check Valve— Accept No Imitations!



In 1984, the United States Environmental Protection Agency (EPA) commissioned Red Valve Company to develop and test an alternative to traditional flap gate valves. In their report, "Development and Evaluation of a Rubber 'Duck Bill' Tide Gate", the EPA stated, "Increasing the reliability and performance of tide gates has a beneficial impact on the general pollution abatement program for the nation's waterways."



In response to the EPA's request, Red Valve developed and patented its now legendary Tideflex® Check Valve. Despite the continual influx of "knockoff" and "look-alike" products, no other check valve offers the unique elastomer technology of the

Tideflex® Valve. No other check valve is as effective in eliminating operational and maintenance problems associated with flap gate check valves, including corrosion of mechanical parts, freezing open or shut and warping and clogging due to entrapped debris.

Since the creation of the Tideflex® Check Valve in 1984, years of research and development, testing and proven performance have led to the development of the next-generation Tideflex® TF-1 and TF-2 Check Valves, along with the patented CheckMate® UltraFlex™ inline Check Valve. These are the world's most reliable valves for backflow prevention. The first Tideflex® Check Valve sold in 1984 is still in service today, with over one million Tideflex® Check Valves reliably solving inflow and backflow challenges.

Independent Hydraulic Testing and Variations

Tideflex® Technologies has conducted extensive independent hydraulic testing of check valves since the 1980s. Comprehensive testing was required and a massive amount of data was analyzed to model the effect of valve geometry and relative stiffness on hydraulics. Check valves are tested in numerous hydraulic variations within each size. Valves are also tested for free discharge, submerged and partially submerged conditions. With extensive test data, Red Valve Company develops modeling programs used to provide hydraulic characteristic curves for every Tideflex® and CheckMate® Check Valve.

Extensive In-house Testing

To supplement the independent hydraulic testing, Red Valve continually conducts research and development and testing to improve existing products and to develop new products. In addition, extensive field studies are conducted to validate product design for long-term performance.

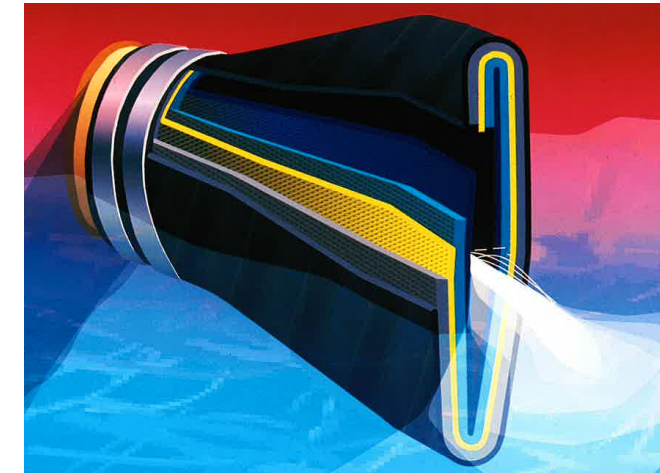

What sets Red Valve products apart from traditional valves is leading-edge elastomer technology. In addition to providing a superior flow pattern, the rubber sleeve provides unsurpassed abrasion and corrosion resistance, closing drop-tight around entrapped solids.

Finite Element Analysis (FEA)

Unlike cheap imitation or "knock off" valves, each Tideflex® Check Valve can possess hundreds of layers of various natural and synthetic elastomers and fabric-reinforced plys. Each valve is custom-designed for specific characteristics such as resilience, durometer, compression set resistance, tensile strength and elongation.

Tideflex® Engineers have created extensive Finite Element Analysis (FEA) models to analyze stress, strain, force and deflection characteristics under many load conditions. Modeling is run for discharging and back pressure conditions, with results used in developing detailed fabrication protocols to ensure Tideflex® Check Valves withstand long-term variable load conditions while producing desired hydraulic characteristics.



Effluent Discharge



Sewer Systems



Airport/Highway Runoff



Stormwater and CSO/SSO Systems



Flood Control Systems

Tideflex® TF-1 Slip-On Check Valve



Materials of Construction

Natural Rubber, Neoprene, Hypalon, Buna-N, EPDM, Chlorobutyl, Fluoroelastomer and NSF-61 certified custom elastomers

Mounting Clamps

Stainless steel 304, SST 316, special alloys available

The Tideflex® TF-1 Check Valve design is the world's most highly regarded check valve for backflow prevention. The TF-1 offers low cracking pressure to eliminate standing water and very low headloss. The valve's all-elastomer fabrication means it will not warp or freeze and is not affected by rust, corrosion or lack of lubrication, requires no maintenance or repairs and boasts a long operational life span.

- TF-1 Valve operates using line pressure and backpressure to open and close, so no outside energy source is required. Sliding, rotating, swinging and plunging parts are completely eliminated.
- Flat-bottom and offset-bill design simplify installation with no modifications to the structure.
- Flat-bottom design is ideal for installation in existing structures such as interceptors, manholes and vaults, where the invert of the pipe is as close to the floor of the vault as possible to maximize head pressure from gravity.
- Ideal for sewer systems—valve seals around small debris with less than one psi of backpressure. TF-1 Valves 18" and larger are constructed with curved bill as standard.
- Curved bill returns to a closed position every time, allowing for a tighter seal in backflow applications.

Tideflex® TF-2



Measurit.com



Materials of Construction

Natural Rubber, Neoprene, Hypalon, Buna-N, EPDM, Chlorobutyl, Fluoroelastomer and NSF-61 certified custom elastomers

Mounting Clamps

Stainless steel 304, SST 316, special alloys available

Tideflex® TF-2 Valves are excellent replacements for ineffective metal flap gate valves. Millions of dollars each year are lost in the retreatment of unnecessary backflow because of faulty check valves that have corroded open or have been wedged open by debris. Tideflex® Check Valves close drop-tight and seal around debris with less than one psi of backpressure. Tideflex® Valves will not warp or freeze and are virtually maintenance-free. They will handle large obstructions without jamming and there is no gate to hang open.

- TF-2 offers low cracking pressure to eliminate standing water and very low head loss.
- All-elastomer fabrication means the valve will not warp or freeze and is not affected by rust, corrosion or lack of lubrication, requires no maintenance or repairs and boasts a long operational life span.
- Valve operates using line pressure and backpressure to open and close, so no outside energy source is required. Sliding, rotating, swinging and plunging parts are completely eliminated.
- The inside diameter of the TF-2 cuff is constructed to exactly match the outside diameter of the pipe. The valve is slid onto the pipe and held in place with specially designed clamps.

Tideflex® Series 35-1 Flanged Check Valve



Materials of Construction

Natural Rubber, Neoprene, Hypalon, Buna-N, EPDM, Chlorobutyl, Fluoroelastomer and NSF-61 certified custom elastomers

Retaining Rings

Galvanized steel, stainless steel 304, SST 316, special alloys available

The flat-bottom Series 35-1 Flanged Check Valve features an integral rubber flange, allowing it to be mounted to flanged outfall pipes or directly to headwalls where the pipe is flush.

The Series 35-1 is often a direct replacement for flanged flap gates, where hinge pins rust and corrode if not routinely lubricated, allowing debris to collect in the seating area of the valve keeping flappers open.

- Series 35-1 Valves 18" and larger are constructed with curved bill as standard.
- Standard flange size drilling conforms to ANSI B16.5 and ANSI B16.47, Class 150 standards. All other domestic and international standards, as well as customer specified flange dimensions, are also available.
- Valve is furnished complete with steel or stainless steel backup rings for installation.

Tideflex® Series 35 Flanged Check Valve



Materials of Construction

Natural Rubber, Neoprene, Hypalon, Buna-N, EPDM, Chlorobutyl, Fluoroelastomer and NSF-61 certified custom elastomers

Retaining Rings

Galvanized steel, stainless steel 304, SST 316, special alloys available

The Series 35 Flanged Check Valve is manufactured identically to the Tideflex® Check Valve, with the addition of an integral elastomer flange as part of the valve. The Series 35 Flanged Check Valve is simple in design, with only one part – the all-rubber duck bill check sleeve.

The Series 35 Flanged Check Valve is ideal for applications and installations where a slip-over pipe check valve is not feasible because of an existing flange in the piping system or an existing flange cemented in the outfall piping system vault.

- There are no seats or interference fits to corrode or freeze valve operation, making it virtually maintenance-free. The Series 35 seals completely around solids, making it ideal for fly ash, raw sewage, sludge, lime, mining slurries and many other abrasive and corrosive slurries.
- Standard flange size drilling conforms to ANSI B16.5 and ANSI B16.47, Class 150 standards. All other domestic and international standards, as well as customer specified flange dimensions, are also available.
- Valve is furnished complete with retaining rings for installation.



Tideflex® Series 33, 39, and 39F In-Line Check Valves



Materials of Construction

Body:

- Cast iron ASTM A126 sizes up to 24"
- Fabricated steel body in sizes 30" - 40"

Sleeves:

- Natural Rubber, Neoprene, Hypalon, Buna-N, EPDM, Chlorobutyl, Fluoroelastomer and NSF-61 certified custom elastomers
- ANSI Class 125/150
- Epoxy coating or rubber-lined body available
- Steel or stainless steel saddle support available

Tideflex® Series 33, 39 and 39F In-Line Check Valves are designed to handle abrasive slurries, sewage, sludge and other difficult materials. The in-line check valve's fabric-reinforced elastomer sleeve provides thru-flow at minimum pressure drop across the valve at all times. Forward pressure opens the valve automatically and reverse pressure seals the valve. Wear and deterioration caused by continuous operation of abrasive slurries are minimized because of the durable inner rubber check valve.

- No mechanical parts, hinges, discs or metal seats to freeze, corrode or bind.
- The unique elastomer check sleeve will seal on solids.
- Silent and non-slamming operation.
- Series 39 and 39F Valves have thru-drilled flange holes. Series 33 valves are pre-tapped. Specify maximum line pressure and backpressure.



Tideflex® Series 37 Flanged In-Line Check Valve



Materials of Construction

- Valves available in Pure Gum Rubber, Neoprene, Hypalon, Buna-N, EPDM and Viton
- ANSI Class 125 Flanges, DIN PN6, PN10, PN16

The Series 37 Flanged In-Line Check Valve is a simple, reliable and cost-effective solution to backflow problems. Designed to be installed between two mating flanges, the Series 37 eliminates the need for a valve body.

With only one moving part, the maintenance-free rubber check sleeve, the Series 37 In-Line Check Valve is simple in design. Sliding, rotating, swinging and spring parts are eliminated, with no seats to corrode or packing to maintain. In addition, the Series 37 is a passive design that requires no external source of air or electricity to operate, resulting in dramatically reduced operating costs.

- The Series 37 In-Line Check Valve can be ordered in a variety of elastomers.
- Flanges conform to ANSI B16.1 Class 125 specifications. Special custom designs or metric flange drillings are also available. When ordering, specify line and backpressure.

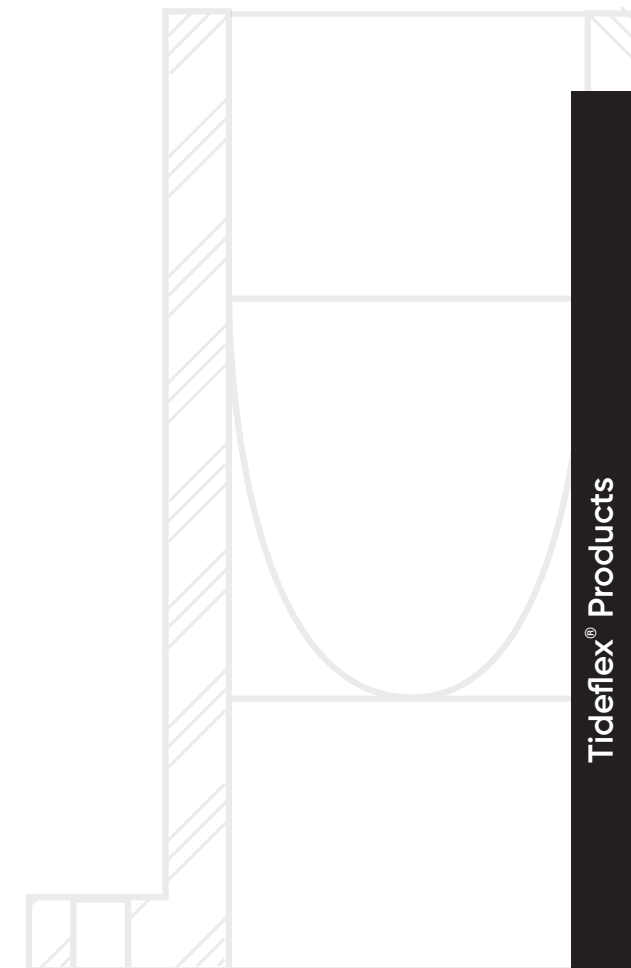

CheckMate® In-Line Check Valve

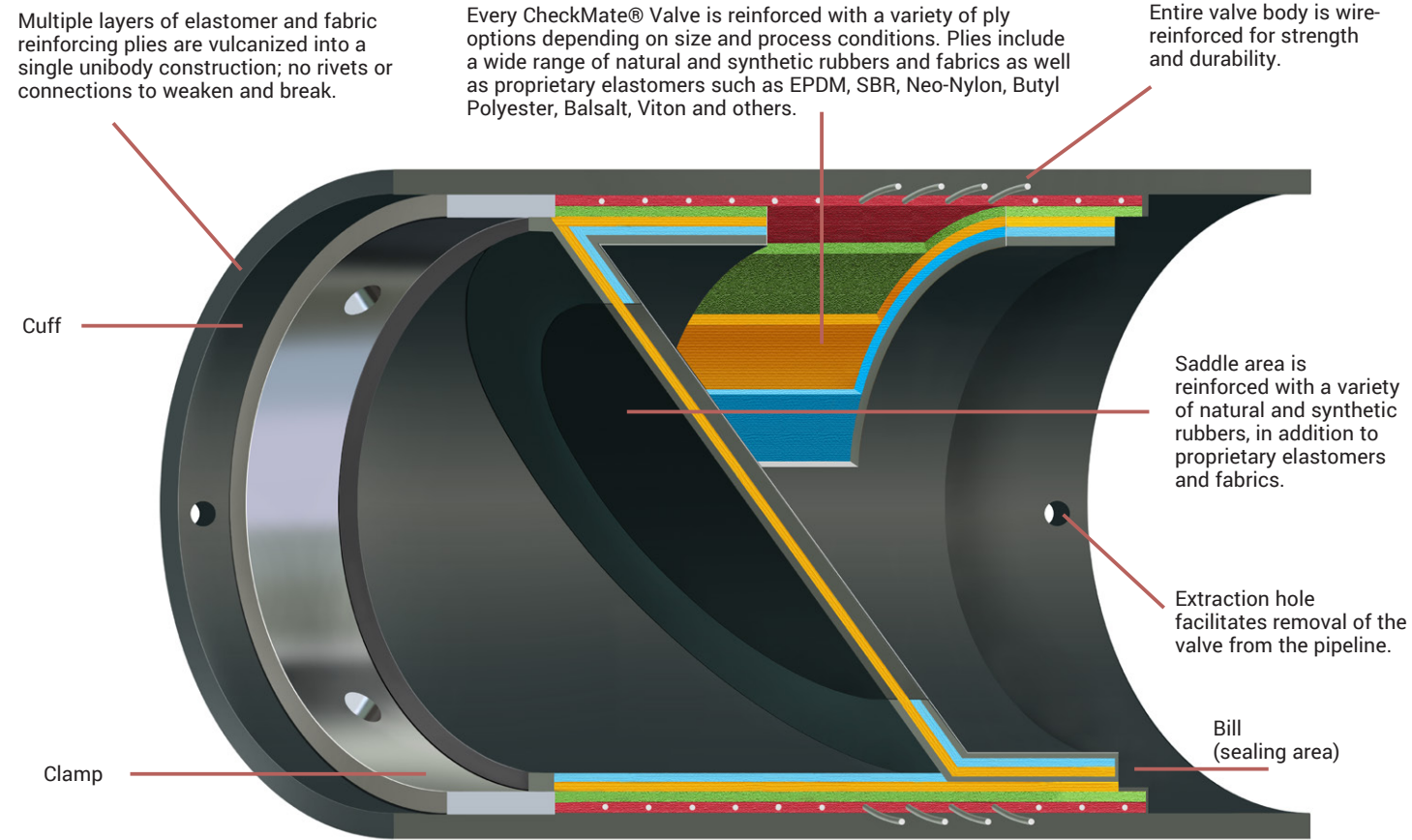

- The professional's choice for both municipal and industrial applications – including storm water, wastewater, highway run-off, CSO, SSO and flood control to prevent unwanted backflow.
- Unlike less engineered, molded in-line check valves held together with rivets, the CheckMate® Valve is hand-fabricated, utilizing various natural and synthetic elastomers and fabric ply reinforcement to create a unibody construction.
- No mechanical parts or fasteners to catch debris, corrode or fail, making CheckMate® extremely durable and maintenance-free.
- Can be custom-engineered to resist chemicals, grease and oils found in storm water, wastewater and industrial applications.
- The most user-friendly in-line check valve on the market today.
- Extremely low head loss, allowing for near 100% flow capacity.
- Easy installation: from the upstream or downstream end of the pipe, simply insert valve into position and clamp into place. No modification to the pipe or structure is typically required to install the CheckMate®. Pre-drilled holes quickly pin valve in position.
- The CheckMate® is recessed inside the pipe--no additional permitting required. The result is savings in both installation time and operational cost.

UltraFlex™: the Next Generation in CheckMate® Technology

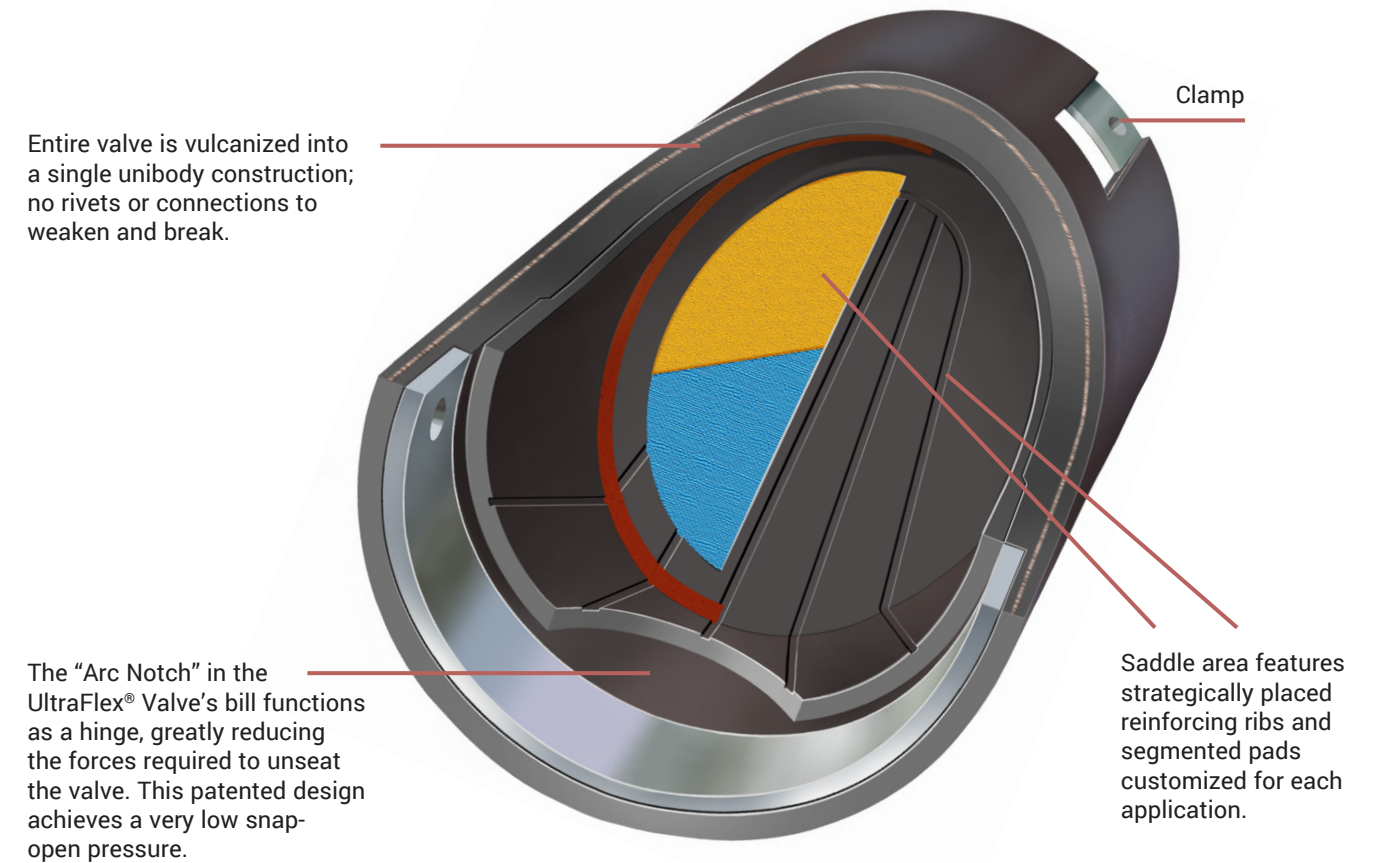

- The patented CheckMate® UltraFlex™ has quickly become the professional's specified choice for residential, municipal and commercial areas where complete, dependable backflow prevention is critical.
- Minimizes damage to wetlands, beaches and residential areas and eliminates hydraulic surges to wastewater treatment plants, saving municipalities millions of dollars in maintenance and treatment costs.
- Exceptional dependability and longevity derived from unmatched elastomer experience, application knowledge and engineering know-how.
- Hand-fabricated, made of multiple layers of varying natural and synthetic elastomers, wire and fabric-reinforced plies, all of which are vulcanized into a robust unibody valve.
- Patented "Arc Notch" and optimized construction enable UltraFlex™ to open 40% faster than other in-line check valves, allowing the pipeline and entire collection system to drain up to 40% faster. The valve "snaps" open with far less head pressure, significantly increasing pipeline capacity, allowing free flow of water during weather events, minimizing chance for standing water to collect upstream.
- Unlike other in-line valve designs, there are no molded parts or mechanical fasteners and rivets that will loosen, act as catch points, break or corrode.

Tideflex® Series 37G Slip-In In-Line Check Valve

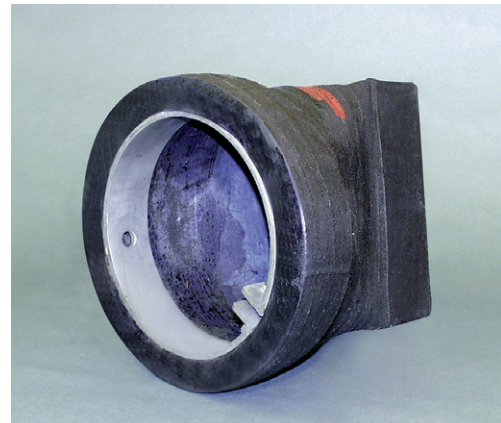

Materials of Construction

- Valves available in Pure Gum Rubber, Neoprene, Hypalon, Buna-N, EPDM and Viton
- Stainless Steel Expansion Clamps

Expansion Clamps

Stainless steel 304, SST 316, special alloys available

The Series 37G Slip-In In-Line Check Valve is a special adaptation of the Series 37. The 37G can be completely inserted into a pipe which effectively gives it a zero face-to-face dimension. The outside diameter of the 37G's cuff is fabricated to precisely match the inside diameter of the pipe, providing a press-fit. The valve is supplied with an internal expansion clamp to provide compression between the valve and pipe I.D. Each clamp has 4 pre-drilled holes that allow the valve to be pinned into position. The 37G can even be fabricated for elliptical or out of round pipe (consult factory for special fabrications).

- As with the Series 37, the bill does not flare and the headloss of the 37G is higher than other styles of Tideflex® Check Valves.
- The 37G is predominantly used in gravity-driven outfall pipes and in manholes and vaults where the valve is inserted into the effluent pipe and compressed to the pipe I.D. with the expansion clamp.
- The 37G can be inserted into the end of a pipe, but access to clamp should be from upstream of the valve, not through the bill of the valve.
- For those applications where there is no access to the upstream side of the valve, the 37G Thimble Insert is the solution.
- For higher backpressure ratings or to lower headloss while maintaining backpressure ratings, the Saddle Support Technology (SST) can be used in conjunction with the Series 37G.



Waterflex® Check Valve



Series WF-2



Series WF-3

Materials of Construction

WF-1

Available in sizes 4" - 36"

Body: Carbon steel, stainless steel, ductile iron

Disc: Carbon steel, stainless steel

Elastomer Membrane: Natural Rubber, Neoprene, Hypalon, Buna-N, EPDM, Chlorobutyl, Fluoroelastomer and NSF-61 certified custom elastomers

WF-2 and WF-3

Available in sizes 4" - 84"

Disc: Carbon steel, stainless steel, PVC (low pressure only)

Elastomer Membrane: Natural Rubber, Neoprene, Hypalon, Buna-N, EPDM, Chlorobutyl, Fluoroelastomer and NSF-61 certified custom elastomers

Wafer-style Waterflex Check Valves are designed specifically for water applications. The Waterflex provides very low headloss characteristics, with high backpressure ratings comparable to other valve styles such as lever and weight or spring-loaded disks.

Waterflex Valves operate solely on line pressure and backpressure to open and close. No outside energy source is required. As line pressure builds, the 100% elastomeric disc is folded away from the perforated plate, allowing water to pass. The "memory" of the rubber will cause the membrane to return flat and backpressure will seal against the disc to prevent backflow. There are no moving parts that require maintenance or repair, so operational costs are low and service life is long. Waterflex Valves also eliminate the need for machined metal parts, further keeping costs down.

- The Series WF-1 Waterflex Valve consists of a two-piece body with ANSI flanges for easy installation or retrofitting. An oversized, integral wafer-style WF-2 sits between the two body pieces, significantly reducing headloss.
- The Series WF-2 Waterflex Valve consists of a perforated plate that is designed to be inserted between two mating flanges. Its face-to-face dimension is the smallest available for any check valve.
- The Series WF-3 Waterflex Valve features a full-faced flange and ANSI bolt drilling to mate between two pipe flanges. Both the WF-2 and WF-3 are lightweight and easy to install. Custom drillings available upon request.

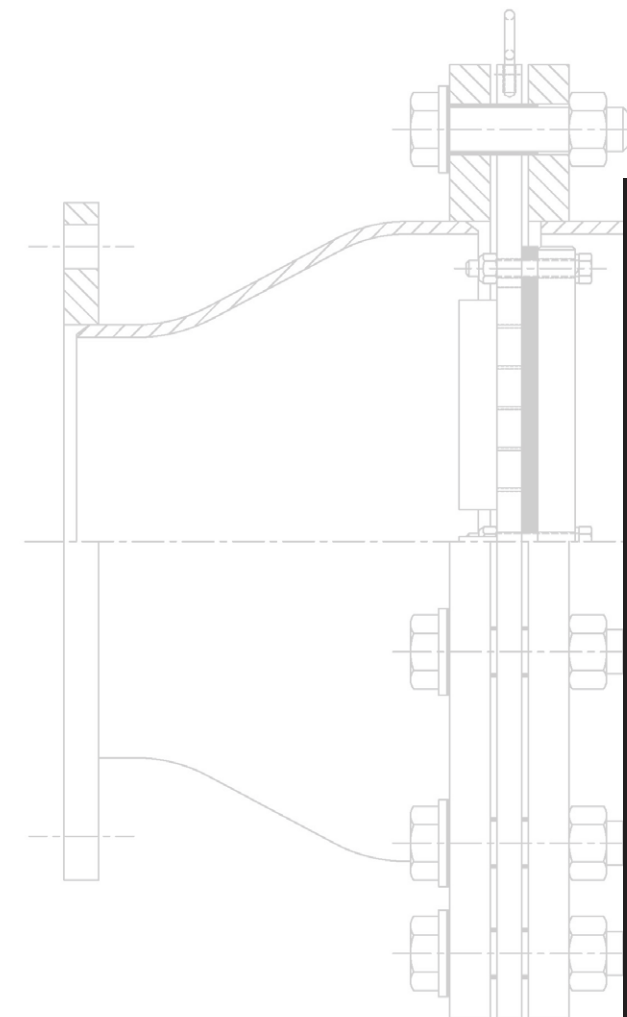

Tideflex® Mixing System (TMS): Science, with Simplicity



For nearly two decades, the Tideflex® Mixing System (TMS) has been providing cost-effective, clean drinking water to thousands of municipalities. Extensively CFD-modeled, scale-modeled and field-validated in all tank styles, the TMS dramatically improves storage tank water quality by eliminating short circuiting and achieving complete mixing.

The TMS is a truly “green technology”, requiring no outside energy source or maintenance, resulting in major cost savings over a minimum 30-year life. Tideflex® Engineers work with you to custom-design the optimal TMS for your tank or reservoir, along with a mixing and water age analysis to ensure complete mixing based on volume turnover. Active systems utilizing re-circulation pumps are also available when required.

Tideflex® Mixing System (TMS) Solves Many Water Quality Problems, Including:

- Loss of disinfectant residual
- Spikes in disinfection by-products (DBP)
- Nitrification in chloraminated systems
- Bacteria and biofilm growth
- Variations in pH and dissolved oxygen
- Aging water
- Thermal stratification
- Ice formation
- Taste and odor issues

TMS: The Professional's Choice for Simple Operation and Mixing Performance

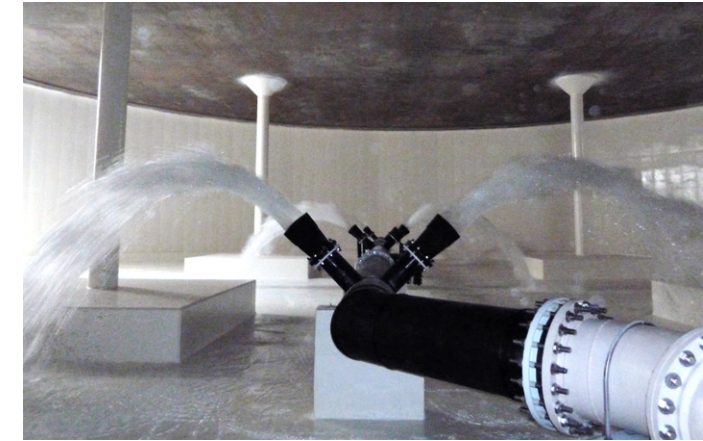

Benefits and Features of TMS

- Extensive CFD and Physical Scale Modeling provided for every tank style.
- Field-validated to achieve complete mixing in every tank style.
- Tideflex® Variable Orifice Nozzles maximize jet velocity, producing rapid mixing.
- No external energy source required.
- Expected life - 30 years, with no maintenance.
- Complete custom system design with Mixing Analysis and Water Age Analysis.
- Installed in ANY size and style of tank.
- Requires only one pipe penetration in tank.
- Tideflex® Variable Orifice Nozzles and Waterflex® Outlet Check Valves are NSF 61 Certified.
- Works with tanks with common or separate inlet and outlet pipes.
- Passive and active systems available.

Multiple Variable Orifice Tideflex® Nozzles

The key to the rapid and complete mixing with the TMS is the multiple Variable Orifice Tideflex® Nozzles that produce a minimum of 75% faster mixing than a single fixed-diameter pipe. In worst-case summer conditions (colder inlet water), the multiple Tideflex® Inlet Nozzles have proven to completely mix tanks in comparison to a single inlet where all the flow momentum is in one location, resulting in short-circuiting and stratification.

Simple Operation

During a fill cycle, fresh water passes through multiple Tideflex® Nozzles, which create a circulation pattern throughout the entire water volume. This rapidly and completely mixes new water throughout the tank. Once the tank is mixed during the fill cycle, it does not “unmix” during the draw cycle.

Unlike mechanical mixers, there is no need to add an additional energy source to mix the water inside the tank. Adding mechanical mixers is essentially paying for energy twice. Having mixers submerged or floating inside the tank also puts an operation and maintenance cost burden on the owner because the motors will need to be replaced every few years, often requiring the tank to be drained. For tanks with minimal or no turnover, mixing 24/7 will not prevent water quality decay as mechanical mixers just mix continually aging water. TMS is truly a “green” technology!

Field Validation and Computational Fluid Dynamics (CFD) Modeling

Through owner-conducted water quality sampling at various locations and depths throughout the tank, the TMS has been validated to achieve complete mixing and improve water quality in chlorinated and chloraminated systems in every tank style. Red Valve’s engineering team uses continuous CFD Modeling to optimize TMS designs and configurations for every size and style of storage tank.

Dechlorinating Overflow Security Assembly (DOSA)



Discharging chlorinated water from storage tank overflows onto land or into a stormwater system can be toxic and severely harmful to plant and aquatic life. To address environmental concerns and potential regulatory penalties, Tideflex® Engineers have created an overflow pipe assembly that prevents bird/rodent intrusion, increases tank security, and removes chlorine and chloramine residual during overflow discharges. The Dechlorinating Overflow Security Assembly (DOSA) is constructed of dual Tideflex® Nozzles and an internal adjustable dechlorination tube completely enclosed in a powder-coated steel body. It is available in sizes 2'-24"; larger sizes are available.

During an overflow event, the upper Tideflex® Nozzle discharges an elliptically-shaped jet down onto a dechlorination tube. A calculated portion of the water passes through the tubes, making contact with the dechlorination tablets. The rest of the water deflects around the tubes. The water then combines in the blending trough to ensure it is thoroughly mixed and

dechlorinated prior to discharging out of the DOSA through the lower Tideflex® Check Valve. DOSA has low headloss and will not clog or freeze. Overflow hydraulic analysis is available.



Tideflex® Effluent Diffuser Nozzles: Superior Performance



Tideflex® Effluent Diffuser Nozzles are used to prevent intrusion of unwanted sand, sediment, saltwater and marine growth into multipoint outfall diffusers. The valves feature a non-mechanical, all-rubber construction that will not corrode and remain unaffected by marine growth.

The unique design of the Effluent Diffuser Nozzle greatly improves the performance of the diffuser system by increasing mixing and initial diffusion through optimized jet velocity. Tideflex® Diffuser Nozzles are maintenance-free and have revolutionized effluent technology for marine and inland outfall diffusers in municipal and industrial applications.

The most important item on an Effluent Diffuser System for controlling initial dilution is its port size. A Diffuser System's ports ensure that peak flows can

be discharged with a limited amount of driving head. Ensuring that ports are the correct size and have the proper configuration is critical.

Tideflex® offers engineering and design support for Effluent Diffuser outfalls and has developed an exclusive computer program to assist engineers in designing Tideflex® diffusers. The program includes data analysis of headloss, total headloss, jet velocity and effective open area. This data can be compared to conventional fixed-orifice diffuser designs to illustrate the hydraulic advantages of Tideflex® Effluent Diffuser Nozzles.

Tideflex® Diffusers can be manufactured with integral wire-reinforced rubber elbows and risers, so there are no cross fittings to deflect when impacted, eliminating damage to the outfall pipe and risers.

Tideflex®: The Intelligent Way to Aerate



Half the Energy, Zero Clogging, None of the Maintenance

The Tideflex® Aeration Mixing System is a sealed system preventing the surrounding wastewater and solids from entering into the diffusers and manifold piping. This provides the capability to cycle the blower on and off as the process requires. For sludge storage processes, this allows for decanting and thickening of the storage residuals as well as denitrification. Most Tideflex® alternating systems reduce blower operating costs by at least 35%.

These Tideflex® Systems are preferred in high solids applications where the clogging potential is significantly increased. Wastewater treatment sludge applications range from 1% to 5% solids and alum sludge applications from 5% to 9% solids.

The Tideflex® System is the only air mixing system rated for these high solids applications, while at the same time providing maintenance-free operation.

The Tideflex® Aeration Mixing System can be applied in anoxic process zones utilizing the ON/OFF operational mode. Most anoxic zones only require periodic mixing of the bio-floc. The Tideflex® System can achieve complete mix within about one minute of operation. This short operational period results in very little oxygen transfer; these anoxic processes are in a negative Oxygen Reduction Potential (ORP) state where the presence of this low oxygen residual has little effect on the ORP state.

A Tideflex® Aeration System for Every Application

Tideflex® Diffused Aeration Mixing Systems

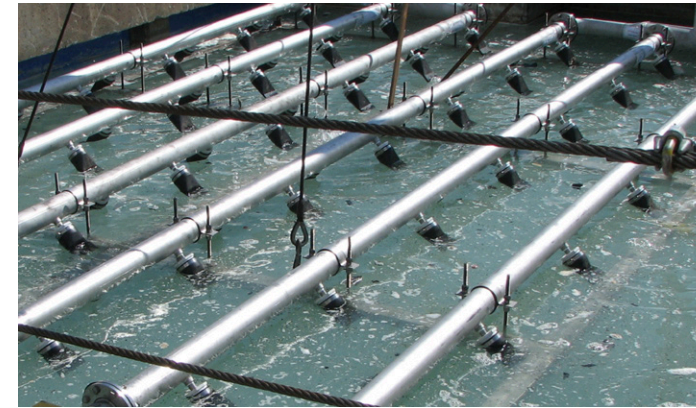

Tideflex® Coarse Bubble Diffusers provide one-way flow operation, discharging gas into fluid while preventing backflow of fluid into the piping system when the discharge gas is off. Provides the option of ON/OFF aeration mode, reducing blower operating costs by 50%. Maintenance-free in high solids applications.

Benefits and Features

- Non-clogging, maintenance-free design with built-in backflow prevention.
- Bottom-mounted diffusers on the manifold automatically purge condensate accumulated in piping.
- Cuts energy consumption by 50%. Blowers can be cycled ON/OFF for power savings, process performance and solids concentrating.
- Ideal for process fluids that have a tendency to produce struvite, which can occur at high velocity points in a system. Any accumulation can easily be removed during maintenance by flexing of the elastomeric nozzle body.
- System can be operated as a bioselector for the development of facultative bacteria to prevent release of H₂S and odors.
- Stainless steel piping and supports ensure long life and durability within the process fluids. EPDM elastomer diffusers have measured life cycles of more than 10 years.

Tideflex® Hydraulic Re-circulation and Mixing Systems



Tideflex® Hydraulic Re-circulation and Mixing Systems pull fluid through pumping systems and re-inject it at high discharge velocities. This increased energy helps mix entire fluid body while maintaining suspension of solids within the fluid. Ideal for applications where mixing with oxygen transfer is detrimental to biological or physical treatment processes.

Benefits and Features

System utilizes multiple hydrodynamic mixing nozzles with enhanced discharge velocity to provide a complete homogeneous mix of the fluid body, including settled solids at the floor.

- The Tideflex® Piping System is the only portion located in the fluid body; EPDM elastomer nozzles prevent any accumulation of struvite or other mineral build-up.
- Does not apply any dissolved oxygen to the process, making it ideal for anoxic cell mixing.
- Ideal for facilities where alum sludge is stored. The Tideflex® System can mix concentrations of alum sludge up to 10% solids.
- System piping constructed of either HDPE or stainless steel for high strength and longevity, far superior to thermoplastic components.
- Tideflex® Hydraulic Mixing Nozzles can be designed to operate with high discharge velocities, ranging from 10 fps up to 45 fps.



Red Valve offers a worldwide, world-class custom service network. With corporate offices in Pittsburgh, PA, manufacturing facilities in Gastonia, NC, and 114 sales representatives in 61 countries around the globe, Red Valve has the sales engineering team to help you select the best choice of valves and related products for your applications.

Represented by:



750 Holiday Drive, Suite 400, Pittsburgh, PA 15220 | 412.279.0044 | www.redvalve.com

The information presented in this catalog is provided in good faith. Red Valve Company, Inc. and Tideflex® Technologies reserves the right to modify or improve its design specifications without notice and does not imply any guarantee or warranty for any of its products from reliance upon the information contained herein. All orders are subject to Red Valve Company, Inc. and Tideflex® Technologies' standard terms and warranty and are subject to final acceptance by Red Valve Company, Inc. and Tideflex® Technologies

Viton is a registered trademark of DuPont Dow Elastomers. Hypalon is a registered trademark of DuPont Performance Elastomers. Teflon is a registered trademark of the DuPont Company. Tideflex, Red Valve, and the Red Valve "rv" logo are registered trademarks of Red Valve Company, Inc.

© 2019 Red Valve Company All rights reserved.